

LMK 458



Probe for Marine and Offshore

Ceramic Sensor

accuracy according to IEC 60770:
standard: 0.25 % FSO
option: 0.1 % FSO

Nominal pressure

from 0 ... 40 cmH₂O up to 0 ... 200 mH₂O

Output signals

2-wire: 4 ... 20 mA
others on request

Special characteristics

- ▶ diameter 39.5 mm
- ▶ LR-certificate (Lloyd's Register)
- ▶ DNV•GL Approval (Det Norske Veritas • Germanischer Lloyd)
- ▶ ABS-certificate (American Bureau of Shipping)
- ▶ CCS-certificate (China Classification Society)
- ▶ high overpressure resistance
- ▶ high long-term stability



Optional versions

- ▶ diaphragm Al₂O₃ 99.9 %
- ▶ different housing materials (stainless steel, CuNiFe)
- ▶ IS-version
Ex ia = intrinsically safe for gas
- ▶ screw-in and flange version
- ▶ accessories e.g. assembling and probe flange, mounting clamp

The hydrostatic probe LMK 458 has been developed for measuring level in service and storage tanks and is certificated for shipbuilding and offshore applications.

A permissible operating temperature up to 125 °C and the possibility to use the device in intrinsic safe areas enable to measure the pressure of various fluids under extreme conditions. The basis for the LMK 458 is a capacitive ceramic sensor element designed by BD|SENSORS, which offers a high overload resistance and medium compatibility.

Preferred areas of use are

-  Water
drinking water abstraction
desalinization plant
- Shipbuilding / Offshore
ballast tanks
-  monitoring of a ship's position and draught
level measurement in ballast and storage tanks



Pressure ranges																
Nominal pressure gauge ¹	[bar]	0.04	0.06	0.1	0.16	0.25	0.4	0.6	1	1.6	2.5	4	6	10	16	20
Level	[mH ₂ O]	0.4	0.6	1	1.6	2.5	4	6	10	16	25	40	60	100	160	200
Overpressure	[bar]	2	2	4	4	6	4	8	8	15	25	25	35	35	45	45
Permissible vacuum	[bar]	-0.2		-0.3		-0.5			-1							
Max. ambient pressure (housing): 40 bar																
¹ available in gauge and absolute; nominal pressure ranges absolute from 1 bar																
Output signal / Supply																
Standard	2-wire: 4 ... 20 mA / V _S = 10 ... 32 V _{DC}								V _S rated = 24 V _{DC}							
Option IS-version	2-wire: 4 ... 20 mA / V _S = 12 ... 28 V _{DC}								V _S rated = 24 V _{DC}							
Performance																
Accuracy ²	standard: ≤ ± 0.25 % FSO								option: for p _N ≥ 0.6 bar ³ : ≤ ± 0.1 % FSO							
Permissible load	R _{max} = [(V _S - V _S min) / 0.02 A] Ω															
Long term stability	≤ ± 0.1 % FSO / year at reference conditions															
Influence effects	supply: 0.05 % FSO / 10 V								permissible load: 0.05 % FSO / kΩ							
Turn-on time	700 msec															
Mean response time	< 200 msec								mean measuring rate 5/sec							
Max. response time	380 msec															
² accuracy according to IEC 60770 – limit point adjustment (non-linearity, hysteresis, repeatability)																
³ under the influence of disturbance burst according to EN 61000-4-4 (2004) +2 kV accuracy decreased to ≤ ± 0.25 % FSO																
Thermal effects (offset and span) / Permissible temperatures																
Tolerance band	≤ ± 1 % FSO								in compensated range -20 ... 80 °C							
Permissible temperatures	medium / electronics / environment: -25 ... 125 °C								storage: -40 ... 125 °C							
Electrical protection ⁴																
Short-circuit protection	permanent															
Reverse polarity protection	no damage, but also no function															
Electromagnetic compatibility	emission and immunity according to - EN 61326 - DNV+GL (Det Norske Veritas • Germanischer Lloyd)															
⁴ additional external overvoltage protection unit in terminal box KL 1 or KL 2 with atmospheric pressure reference available																
Mechanical stability																
Vibration	4 g (according to DNV+GL: class B, curve 2 / basis: DIN EN 60068-2-6)															
Electrical connection																
Cable with sheath material ⁵	TPE-U blue Ø 7.4 mm															
Bending radius	static installation: 10-fold cable diameter								dynamic application: 20-fold cable diameter							
⁵ shielded cable with integrated ventilation tube for atmospheric pressure reference (for nominal pressure ranges absolute, the ventilation tube is closed)																
Materials																
Housing	standard: stainless steel 1.4404 (316L)								option: CuNi10Fe1Mn (resistant against sea water) others on request							
Seals (media wetted)	standard: FKM								options: EPDM, FFKM (min. permissible temperature from -15 °C) others on request							
Diaphragm	standard: ceramics Al ₂ O ₃ 96 %								option: ceramics Al ₂ O ₃ 99.9 %							
Protection cap	POM-C															
Cable sheath	TPE-U (flame-resistant, halogen free, increased resistance against oil and gasoline, resistant against salt, sea water, heavy oil)															
Miscellaneous																
Option cable protection for probes in stainless steel	prepared for mounting with stainless steel pipe; available as compact product (standard: stainless steel pipe with a total length up to 2 m possible; other lengths on request)															
Ingress protection	IP 68															
Current consumption	max. 21 mA															
Weight	min. 650 g (without cable)															
CE-conformity	EMC Directive: 2014/30/EU															
ATEX Directive	2014/34/EU															
Option Pt 100 temperature element ⁶																
Temperature range	-25 ... 125 °C															
Connection temperature element	3-wire															
Resistance	100 Ω at 0 °C															
Temperature coefficient	3850 ppm/K															
Supply I _S	0.3 ... 1.0 mA _{DC}															
⁶ not possible in combination with IS-version																
Category of the environment																
Lloyd's Register (LR)	EMV1, EMV2, EMV3, EMV4								number of certificate: 13/20056							
Det Norske Veritas • Germanischer Lloyd (DNV+GL)	temperature: D				vibration: B				number of certificate: TAA00001GM							
	humidity: B				enclosure: D				electromagnetic compatibility: B							
Explosion protection ⁷																
Approval DX14A-LMK 458	IBExU 07 ATEX 1180 X								zone 0 ⁸ : II 1G Ex ia IIB T4 Ga							
Safety technical maximum values	U _i = 28 V, I _i = 93 mA, P _i = 660 mW, C _i = 105 nF; L _i = 0 μH; the supply connections have an inner capacity of max. 140 nF opposite the enclosure															
Permissible temperatures for environment	in zone 0: -20 ... 60 °C with p _{atm} 0.8 bar up to 1.1 bar zone 1 and higher: -25 ... 70 °C															
Connecting cables (by factory)	cable capacity: signal line/shield as well as signal line/signal line: 160 pF/m cable inductance: signal line/shield as well as signal line/signal line: 1 μH/m															
⁷ not possible in combination with Pt 100 temperature element																
⁸ for optional stainless steel pipe the following designation is valid: "II 1 G Ex ia IIC T4" (zone 0)																

LMK 458

Probe for Marine and Offshore

Technical Data

Wiring diagrams

2-wire-system (current)

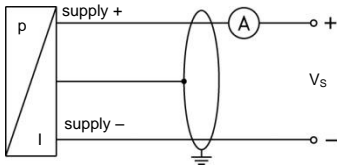

2-wire-system current (pressure) / 3-wire-system (temperature)

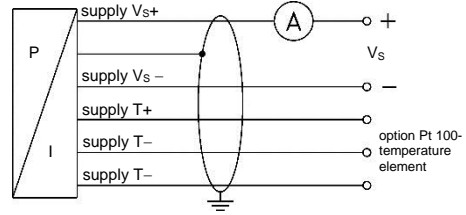

Pin configuration

Electrical connection	cable colours (IEC 60757)
Supply Vs +	WH (white)
Supply Vs -	BN (brown)
Option Pt 100 temperature element:	
Supply T+	YE (yellow)
Supply T-	GY (grey)
Supply T-	PK (pink)
Shield	GNYE (green-yellow)

Dimensions for housing in stainless steel and CuNiFe (mm / in)

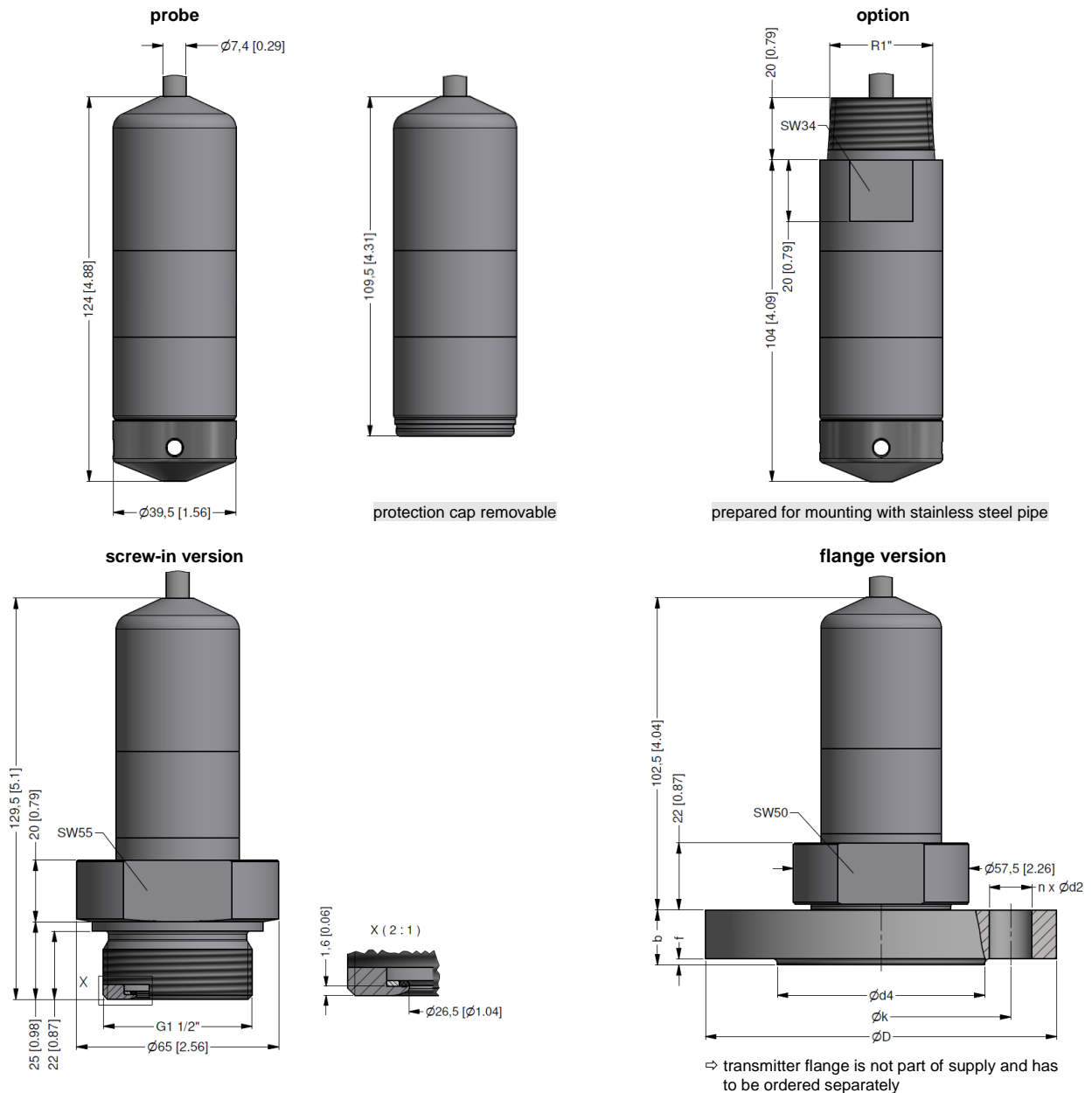

Transmitter flange for flange version

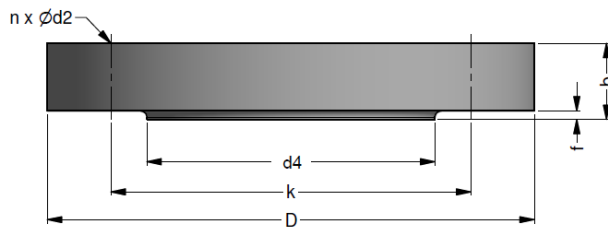

dimensions in mm			
size	DN25 / PN40	DN50 / PN40	DN80 / PN16
b	18	20	20
D	115	165	200
d2	14	18	18
d4	68	102	138
f	2	3	3
k	85	125	160
n	4	4	8

Technical data

Suitable for	LMK 382, LMK 382H, LMK 458, LMK 458H
Flange material	stainless steel 1.4404 (316L)
Hole pattern	according to DIN 2507

Ordering type	Ordering code	Weight
Transmitter flange DN25 / PN40	ZSF2540	1.2 kg
Transmitter flange DN50 / PN40	ZSF5040	2.6 kg
Transmitter flange DN80 / PN16	ZSF8016	4.1 kg

Mounting flange with cable gland

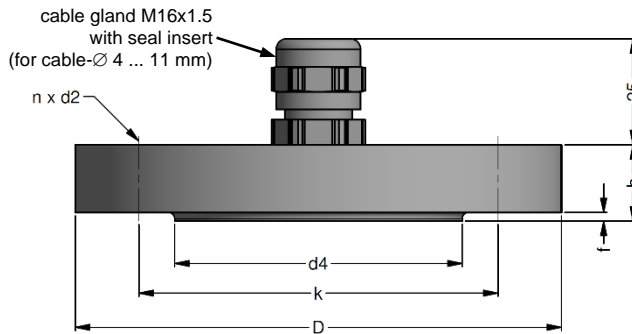

dimensions in mm			
size	DN25 / PN40	DN50 / PN40	DN80 / PN16
b	18	20	20
D	115	165	200
d2	14	18	18
d4	68	102	138
f	2	3	3
k	85	125	160
n	4	4	8

Technical data

Suitable for	all probes
Flange material	stainless steel 1.4404 (316L)
Material of cable gland	standard: brass, nickel plated on request: stainless steel 1.4305 (303); plastic
Seal insert	material: TPE (ingress protection IP 68)
Hole pattern	according to DIN 2507

Ordering type	Ordering code	Weight
DN25 / PN40 with cable gland brass, nickel plated	ZMF2540	1.4 kg
DN50 / PN40 with cable gland brass, nickel plated	ZMF5040	3.2 kg
DN80 / PN16 with cable gland brass, nickel plated	ZMF8016	4.8 kg

Ordering code LMK 458

LMK 458



Pressure										
	in bar, gauge	7	6	5						
	in bar, absolute ¹	7	6	8						
	in mH ₂ O	7	6	6						
Input										
	[mH ₂ O]	[bar]								
	0.4	0.04	0	4	0	0				
	0.6	0.06	0	6	0	0				
	1.0	0.10	1	0	0	0				
	1.6	0.16	1	6	0	0				
	2.5	0.25	2	5	0	0				
	4.0	0.40	4	0	0	0				
	6.0	0.60	6	0	0	0				
	10	1.0	1	0	0	1				
	16	1.6	1	6	0	1				
	25	2.5	2	5	0	1				
	40	4.0	4	0	0	1				
	60	6.0	6	0	0	1				
	100	10	1	0	0	2				
	160	16	1	6	0	2				
	200	20	2	0	0	2				
	customer		9	9	9					consult
Housing										
	stainless steel 1.4404 (316L)		1							
	copper-nickel-alloy (CuNi10Fe1Mn)		K							
	customer		9							consult
Design										
	probe		1							
	flange version ²		3							
	screw-in version		5							
Diaphragm										
	ceramics Al ₂ O ₃ 96%		2							
	ceramics Al ₂ O ₃ 99.9%		C							
	customer		9							consult
Output										
	4 ... 20 mA / 2-wire		1							
	intrinsic safety 4 ... 20 mA / 2-wire		E							
	customer		9							consult
Seals										
	FKM		1							
	EPDM		3							
	FFKM ³		7							
	customer		9							consult
Electrical connection										
	TPE-U-cable (blue, Ø 7.4 mm) ⁴		4							
	customer		9							consult
Accuracy										
	standard	0.25 % FSO				2				
	option für P _N ≥ 0.6 bar:	0.1 % FSO				1				
	customer		9							consult
Cable length										
	in m						9	9	9	
Special version										
	standard						0	0	0	
	with temperature sensor Pt 100 ⁵						0	1	3	
	prepared for mounting ⁶						5	0	2	
	with stainless steel pipe									
	customer		9	9	9					consult

¹ nominal pressure ranges absolute from 1 bar

² mounting accessories are not part of supply and have to be ordered separately

³ min. permissible temperature from -15°C

⁴ shielded cable with integrated ventilation tube for atmospheric reference

⁵ not possible in combination with IS-version

⁶ possible for probes in stainless steel; stainless steel pipe is not part of the supply