

DMP 333

Industrial Pressure Transmitter for High Pressure

Stainless Steel Sensor

accuracy according to IEC 60770:
standard: 0.35 % FSO
option: 0.25 / 0.1 % FSO



Nominal pressure

from 0 ... 100 bar up to 0 ... 600 bar

Output signals

2-wire: 4 ... 20 mA
3-wire: 0 ... 20 mA / 0 ... 10 V
others on request

Special characteristics

- ▶ excellent long-term stability, also with high dynamic pressure loads
- ▶ insensitive to pressure peaks
- ▶ high overpressure capability

Optional versions

- ▶ IS-version
Ex ia = intrinsically safe for gases and dusts
- ▶ SIL 2 version according to IEC 61508 / IEC 61511
- ▶ customer specific versions

The pressure transmitter type DMP 333 has been especially designed for use in hydraulic applications with high static and dynamic pressure. The transmitter is characterized by an excellent long term stability, also under fast changing pressure as well as positive and negative pressure peaks.

The modular concept of the device allows to combine different stainless steel sensors and electronic modules with a variety of electrical and mechanical versions. Thus a diversity of variations is created, meeting almost all requirements in hydraulic applications.

Preferred areas of use are

Plant and machine engineering

Machine tools
Hydraulic presses
Injection moulding machine
Handling equipment
Elevated platforms
Test benches



Mobile hydraulics



DMP 333

Industrial Pressure Transmitter

Technical Data

Input pressure range					
Nominal pressure gauge ¹ / abs. [bar]	100	160	250	400	600
Overpressure [bar]	210	600	1000	1000	1000
Burst pressure ≥ [bar]	1000	1000	1250	1250	1800

¹ measurement starts with ambient pressure

Output signal / Supply		
Standard	2-wire: 4 ... 20 mA / $V_S = 8 \dots 32 V_{DC}$	SIL-version: $V_S = 14 \dots 28 V_{DC}$
Option IS-protection	2-wire: 4 ... 20 mA / $V_S = 10 \dots 28 V_{DC}$	SIL-version: $V_S = 14 \dots 28 V_{DC}$
Options 3-wire	3-wire: 0 ... 20 mA / $V_S = 14 \dots 30 V_{DC}$ 0 ... 10 V / $V_S = 14 \dots 30 V_{DC}$	

Performance	
Accuracy ²	standard: $\leq \pm 0.35\%$ FSO option 1: $\leq \pm 0.25\%$ FSO option 2: $\leq \pm 0.1\%$ FSO
Permissible load	current 2-wire: $R_{max} = [(V_S - V_{S min}) / 0.02 A] \Omega$ current 3-wire: $R_{max} = 240 \Omega$ voltage 3-wire: $R_{min} = 10 k\Omega$
Influence effects	supply: 0.05 % FSO / 10 V load: 0.05 % FSO / $k\Omega$
Long term stability	$\leq \pm 0.1\%$ FSO / year at reference conditions
Response time	2-wire: ≤ 10 msec 3-wire: ≤ 3 msec

² accuracy according to IEC 60770 – limit point adjustment (non-linearity, hysteresis, repeatability)

Thermal effects (Offset and Span)	
Tolerance band	$\leq \pm 0.75\%$ FSO
in compensated range	0 ... 70 °C

Permissible temperatures	
Permissible temperatures	medium: -40 ... 125 °C electronics / environment: -40 ... 85 °C storage: -40 ... 100 °C

Electrical protection	
Short-circuit protection	permanent
Reverse polarity protection	no damage, but also no function
Electromagnetic compatibility	emission and immunity according to EN 61326

Mechanical stability	
Vibration	10 g RMS (25 ... 2000 Hz) according to DIN EN 60068-2-6
Shock	100 g / 11 msec according to DIN EN 60068-2-27

Materials	
Pressure port	stainless steel 1.4404 (316 L)
Housing	stainless steel 1.4404 (316 L)
Option compact field housing	stainless steel 1.4301 (304); cable gland M12x1.5, brass, nickel plated (clamping range 2 ... 8 mm)
Seals	standard: FKM options: EPDM (for $p_N \leq 160$ bar) others on request
Diaphragm	stainless steel 1.4435 (316 L)
Media wetted parts	pressure port, seals, diaphragm

Explosion protection (only for 4 ... 20 mA / 2-wire)	
Approvals DX19-DMP 333	IBExU 10 ATEX 1068 X / IECEx IBE 12.0027X zone 0: II 1G Ex ia IIC T4 Ga zone 20: II 1D Ex ia IIIC T135 °C Da
Safety technical maximum values	$U_i = 28 V_{DC}$, $I_i = 93$ mA, $P_i = 660$ mW, $C_i \approx 0$ nF, $L_i \approx 0$ μ H, the supply connections have an inner capacity of max. 27 nF to the housing
Permissible temperatures for environment	in zone 0: -20 ... 60 °C with p_{atm} 0.8 bar up to 1.1 bar in zone 1 or higher: -40/-20 ... 70 °C
Connecting cables (by factory)	cable capacitance: signal line/shield also signal line/signal line: 160 pF/m cable inductance: signal line/shield also signal line/signal line: 1 μ H/m

Miscellaneous		
Option SIL2 version ³	according to IEC 61508 / IEC 61511	
Current consumption	signal output current: max. 25 mA	signal output voltage: max. 7 mA
Weight	approx. 140 g	
Installation position	any ⁴	
Operational life	100 million load cycles	
CE-conformity	EMC Directive: 2014/30/EU	Pressure Equipment Directive: 2014/68/EU (module A) ⁵
ATEX Directive	2014/34/EU	

³ only for 4 ... 20 mA / 2-wire, not in combination with accuracy 0.1 %

⁴ Pressure transmitters are calibrated in a vertical position with the pressure connection down.

⁵ This directive is only valid for devices with maximum permissible overpressure > 200 bar.

Wiring diagrams

2-wire-system (current)

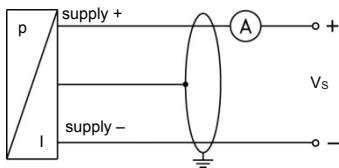

3-wire-system (current / voltage)

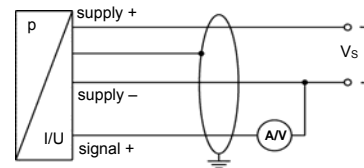

Pin configuration

Electrical connection	ISO 4400	Binder 723 (5-pin)	M12x1/ metal (4-pin)	Bayonet MIL-C-26482 (10-6)		compact field housing	cable colours (IEC 60757)
				2-wire	3-wire		
Supply +	1	3	1	A	A	IN +	WH (white)
Supply -	2	4	2	B	D	IN -	BN (brown)
Signal + (for 3-wire)	3	1	3	-	B	OUT +	GN (green)
Shield	ground pin	5	4	pressure port			GNYE (green-yellow)

Electrical connections (dimensions in mm)

standard

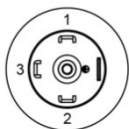
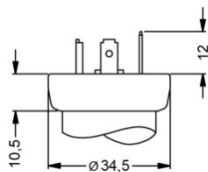

ISO 4400 (IP 65)

options

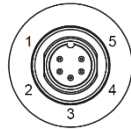
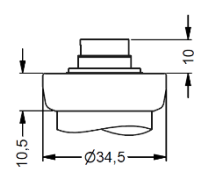

Binder series 723 5-pin (IP 67)

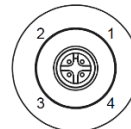
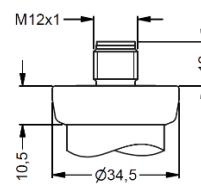

M12x1 4-pin (IP 67)

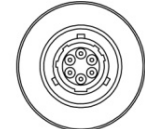
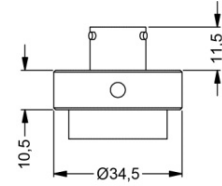

Bayonet MIL-C-26482 (10-6) (IP 67)

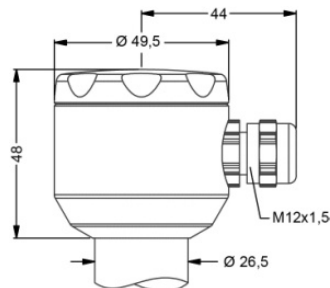

compact field housing (IP 67)

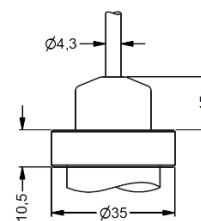

cable outlet with PVC cable (IP 67) ⁶

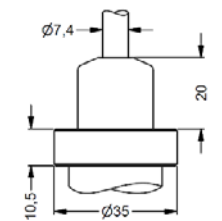

cable outlet, cable with ventilation tube (IP 68) ⁷

⇒ universal field housing stainless steel 1.4404 (316 L) with cable gland M20x1.5 (ordering code 880) and other versions on request

⁶ standard: 2 m PVC cable without ventilation tube (permissible temperature: -5 ... 70 °C)

⁷ different cable types and lengths available, permissible temperature depends on kind of cable

Mechanical connections (dimensions in mm)

standard for accuracy 0.35 / 0.25 %

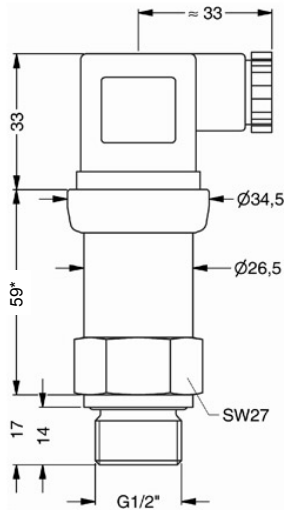

G1/2" DIN 3852
with ISO 4400

standard for accuracy 0.1 %;
SIL- and SIL-IS-version

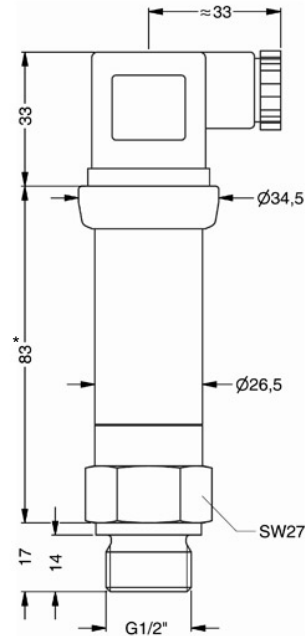

G1/2" DIN 3852
with ISO 4400

option

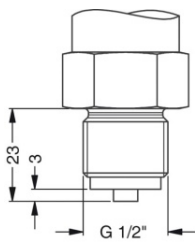

G1/2" EN 837

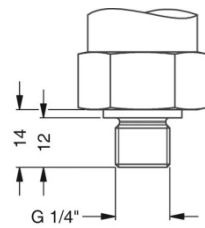

G1/4" DIN 3852

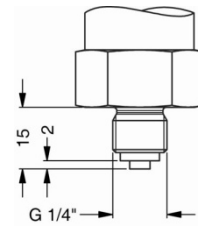

G1/4" EN 837

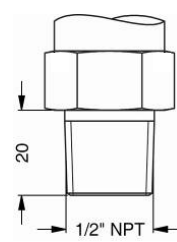

1/2" NPT

⇒ metric threads and other versions on request

* with electrical connection Bayonet MIL-C-26482 (10-6) increases the length of devices by 5 mm

© 2020 BD/SENSORS GmbH - The specifications given in this document represent the state of engineering at the time of publishing. We reserve the right to make modifications to the specifications and materials.

Ordering code DMP 333

DMP 333



Pressure										
gauge ¹	1	3	0							
absolute	1	3	1							
Input [bar]										
100				1	0	0	3			
160				1	6	0	3			
250				2	5	0	3			
400				4	0	0	3			
600				6	0	0	3			
customer				9	9	9	9		consult	
Output										
4 ... 20 mA / 2-wire								1		
0 ... 20 mA / 3-wire								2		
0 ... 10 V / 3-wire								3		
intrinsic safety 4 ... 20 mA / 2-wire								E		
SIL2 4 ... 20 mA / 2-wire								1S		
SIL2 with Intrinsic safety 4 ... 20 mA / 2-wire								ES		
customer								9	consult	
Accuracy										
standard:	0.35 % FSO							3		
option 1:	0.25 % FSO							2		
option 2:	0.10 % FSO ²							1		
customer								9	consult	
Electrical connection										
male and female plug ISO 4400								1	0	0
male plug Binder series 723 (5-pin)								2	0	0
cable outlet with PVC cable (IP67) ³								T	A	0
cable outlet,								T	R	0
cable with ventilation tube (IP68) ⁴								T	R	0
male plug M12x1 (4-pin) / metal								M	1	0
Bayonet MIL-C-26482 (10-6); 2 wire								B	G	0
Bayonet MIL-C-26482 (10-6); 3 wire								B	G	4
compact field housing								8	5	0
stainless steel 1.4301 (304)								9	9	9
customer								9	9	9
Mechanical connection										
G1/2" DIN 3852								1	0	0
G1/2" EN 837								2	0	0
G1/4" DIN 3852								3	0	0
G1/4" EN 837								4	0	0
1/2" NPT								N	0	0
customer								9	9	9
Seals										
FKM								1		
EPDM ⁵								3		
customer								9		
Special version										
standard								0	0	0
customer								9	9	9
										consult

¹ measurement starts with ambient pressure

² not in combination with SIL

³ standard: 2 m PVC cable without ventilation tube (permissible temperature: -5 ... 70 °C); others on request

⁴ code TR0 = PVC cable, cable with ventilation tube available in different types and lengths

⁵ possible for nominal pressure ranges $p_N \leq 160$ bar